

INTERIM 313 OVERFLOW TRAP

INSTALLATION, OPERATION & MAINTENANCE INSTRUCTIONS



TABLE OF CONTENTS

Overview	Cover
General Information	Cover
Installation	4
Operation	4
Maintenance	4
Float Ball Level Test Procedure	5
Float Ball Level Adjustment Procedure..	6
Information Present on 313's	7
Overflow Trap Specifications.....	8
Overhaul / Parts Kits	9 & 10
Drawings.....	11-14
313 Kit Proceedures.....	15 & 16

313_IOM_RevDb_0622

PRODUCT OVERVIEW

This document covers the installation, operation and maintenance of 313 Overflow Traps presented in the "Level Controls and Accessories"; Product Specification.

GENERAL INFORMATION

The instructions given herein cover generally the operation and maintenance of subject equipment. Should any questions arise which may not be answered specifically by these instructions, they should be referred to Warren Controls Inc. for further detailed information and technical assistance. This manual cannot possibly cover every situation connected with the operation, adjustment, inspection, test, overhaul and maintenance of the equipment furnished. Every effort is made to prepare the text of this manual so that engineering and design data is transformed into the most easily understood wording. Warren Controls Inc., in furnishing this equipment and this manual, must presume that the operation and maintenance personnel assigned thereto have sufficient technical knowledge and experience to apply sound safety and operational

practices which may not be covered herein. In applications where Warren Controls Inc. furnished equipment is to be integrated with a process or other machinery, these instructions should be thoroughly reviewed to determine the proper integration of the equipment into the overall plant operational procedures. **Warren Controls does not assume responsibility for the selection, use, or maintenance of any product. Responsibility for proper selection, use, and maintenance of any Warren Controls product remains solely with the purchaser and end-user.**



WARNING

CHECK OVERFLOW TRAP FOR ANY DAMAGE DUE TO IMPROPER STORAGE OR TRANSPORTATION. IMMEDIATELY NOTIFY YOUR SALES ORGANIZATION OF ANY DAMAGED GOODS UPON RECEIPT. DO NOT ATTEMPT TO MOVE OR DISTURB THE OVERFLOW TRAP FURTHER SO PHOTOS MAY BE TAKEN. IF THE SHIPPING CONTAINER IS NOTICEABLY DAMAGED REFUSE RECEIPT, AS THE SHIPPING COMPANY SHOULD BE HELD LIABLE UNTIL A SHIPPING REPRESENTATIVE IS AVAILABLE TO TAKE PHOTOS.

WARREN CONTROLS LEVEL CONTROLS AT WORK...

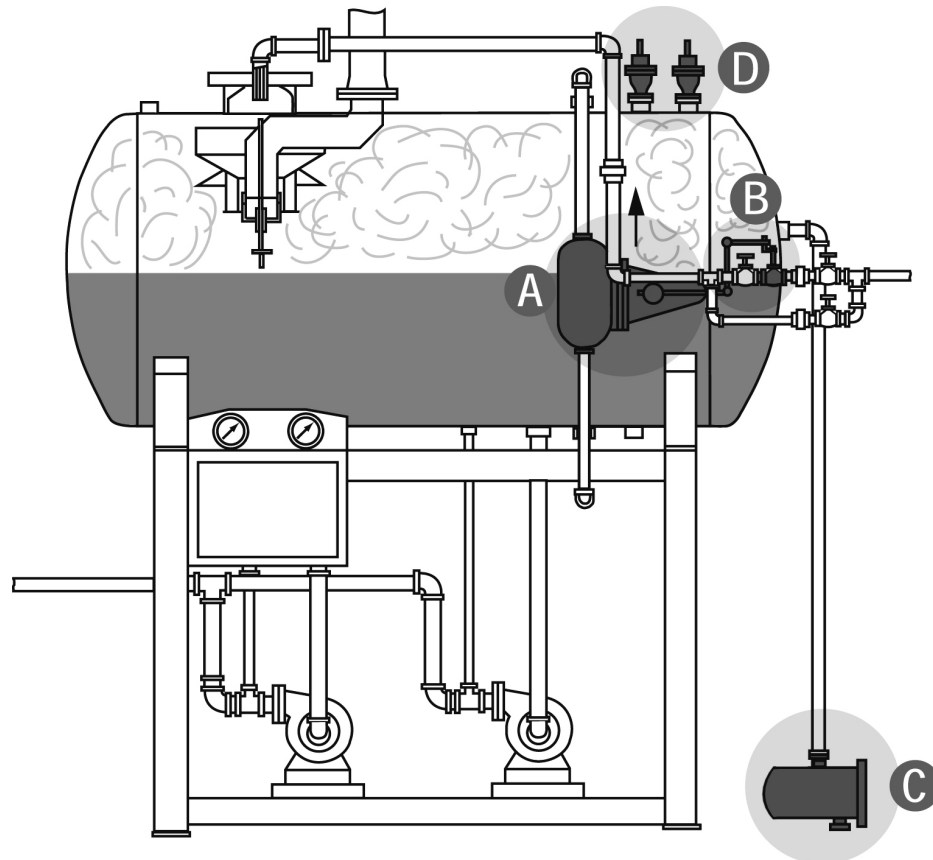

The following is a typical example of a tank filling/deaerator application using properly sized, selected, and maintained Warren Controls Level Controls. Demand for water reduces the liquid level in the tank. The [A] **377 Float Cage** opens the [B] **322L or 326L Lever Valve** to supply intake water to the tank. When the water reaches the desired level the float cage closes the lever valve to accurately maintain the liquid at the desired level. Deaerators, tanks with steam blankets, produce additional liquid as the steam condenses. The [C] **313 Overflow Trap** traps and relieves this condensate through its internal pilot without the steam blanket escaping. Overflow can occur if the water entering the tank exceeds its capacity. The 313 Overflow Trap relieves the overflow through its internal single seated main stage valve. Falling liquid levels and condensing steam can cause a vacuum that can damage the tank. The [D] **200 Vacuum Breaker** opens to admit outside air to relieve the vacuum in the tank. Warren Controls Level Controls are also used on boiler make-up water tanks and many other storage tank applications.

INSTALLATION – TYPE 313 OVERFLOW TRAP

- To determine which 313 Overflow Trap you have locate the part number on the factory serial number label (See [Information Present on 313 Overflow Trap](#) section for location of important information on overflow traps). Then see [313 Overflow Trap Specifications](#) section to determine the performance and physical characteristics of the overflow trap).
- The overflow trap must be installed in vertical pipe with its inlet up as shown on the installation orientation label or cast tanks name plate (See [Information Present on 313 Overflow Trap](#) section for location of important information on overflow traps).
- Downstream piping **must** be open to atmosphere as close as possible to output of 313.
- Outlet must not become submerged in liquid in drain.
- Eliminate vibration in piping. 313 Overflow Traps are not suitable in installations where vibration exists.
- Before installing, be sure the 313 Overflow Trap and piping are clean inside and free of scale, chips, welding spatter, and foreign material. Thoroughly blow out or flush pipe lines.
- Do not obscure factory serial number label, cast tanks name plate, or installation orientation label with paint.
- Pipe plug must be installed in float chamber during operation.

WARNING: The 3 and 4 inch size 313 Overflow Traps have an ANSI 125Lb flat face flange on the inlet and outlet connections; mating piping **MUST** also have a flat face flange. If the existing mating piping for a 3 inch or 4 inch 313 Overflow Trap has a raised face flange then the raised face **MUST BE REMOVED**.

OPERATION – TYPE 313 OVERFLOW TRAP

- Deaerators, tanks with steam blankets, produce condensate as the steam condenses. The 313 Overflow Trap traps and relieves this condensate through its internal pilot while keeping the steam blanket from escaping. Overflow can occur if the water entering the tank exceeds its capacity. The 313 Overflow Trap relieves the overflow through its internal single seated main stage valve. Buoyancy of the overflow trap's internal float ball provides force to actuate the internal pilot operated single seated valve assembly to relieve condensate and overflow to drain. It is normal for condensate to intermittently flash to steam as it is relieved to the drain. Steam from the steam blanket however should not be continuously exiting the overflow trap to the drain.

MAINTENANCE – TYPE 313 OVERFLOW TRAP

- 313 Overflow Traps for the most part are maintenance free when sized and chosen properly for the application. Maintain the fluid pressure, pressure drop, and temperature within the limits of the overflow trap (See [Information Present on 313 Overflow Trap](#) section for location of important information on overflow trap and [313 Overflow Trap Specifications](#) section to determine the performance and physical characteristics of the overflow trap).
- The inlet and outlet of the overflow trap must be kept unblocked. The internal pilot operated single seated valve assembly must be kept free of debris, deposits, and dirt. The internal pilot operated single seated valve assembly must move freely. The float ball must **not** become filled with water. The float lever **must** be straight. Factory set-up of the overflow trap is shown on drawing 03131004211.
- The water level inside the float chamber must cover the windows in the valve body in order for the main stage to open.
- Perform Float Ball Level Test during scheduled maintenance periods. Float ball level must be correct for water to be at correct level in the float chamber. A set-up fixture may also be fabricated as shown on drawing 03130614111 to test and set the float ball level.
- Pipe plug must be installed in float chamber during operation.

OVERHAUL

Rebuilding of the overflow trap should not be necessary under normal operating conditions. Should the overflow trap become worn or damaged, parts kits are available. See Parts/ Overhaul.

FLOAT BALL LEVEL TEST PROCEDURE

WARNING: In order to service the Type 313 Overflow Trap it is permitted to loosen or remove the hex head capscrews (Item 24), the hex head capscrews (Item 18), and the 3/4 NPT square head pipe plug (Item 26). It is not permitted to loosen or remove any of the other fasteners that are part of the float chamber subassembly (Item 21). It is not permitted to loosen or remove the large square head pipe plug on the end of the float chamber subassembly opposite the end cover (Item 25). If any of the other fasteners or the large pipe plug that are part of the float chamber subassembly are loosened or removed the pressure boundary of the 313 will be compromised voiding the warranty.

- 1) Remove line pressure and isolate overflow trap. **(It is recommended that you have an Inspection Kit on hand before beginning the procedure.)**
- 2) Remove fasteners (Item 24) from end cover (Item 25).
- 3) Remove end cover from float chamber subassembly (Item 21).
- 4) Remove end cover gasket (Item 23).
- 5) Remove capscrews (Item 18) holding inner valve body (Item 15) to float chamber subassembly.
- 6) Remove internal valve assembly with float ball from float chamber subassembly.
- 7) Install internal valve assembly with float ball in float chamber subassembly with float ball extending out of the open end of the float chamber subassembly. Use clamps to secure internal valve assembly with float ball to float chamber subassembly.
- 8) With piston (disc) (Item 20) seated in inner valve body and pilot subassembly (Item 16) seated on piston (disc), measure vertical distance from bottom of float ball (Item 4) to bottom of inner valve body.
- 9) Compare measurement to values in Float Ball Level Table. If measurement is within the range of values in table complete remaining steps. If measurement is not within range of values in table perform Steps 8 thru 20 of Float Ball Level Adjustment Procedure.
- 10) Remove clamps and remove internal valve assembly with float ball from float chamber subassembly.
- 11) Remove inner valve body gasket (Item 19).
- 12) Clean gasket surfaces of end cover, inner valve body, and float chamber subassembly.
- 13) Install new inner valve body gasket in float chamber subassembly.
- 14) Install internal valve assembly with float ball in float chamber subassembly. Watch orientation.
- 15) Install capscrews in inner valve body and tighten to secure inner valve body to float chamber subassembly.
- 16) Install new end cover gasket on float chamber subassembly. **The parts kits for Type 313 Overflow Traps size 1, 1-1/2, 2 and 3 inch contain two different end cover gaskets, see "Which end cover gasket do I use?" on page 16.**
- 17) Install end cover on float chamber subassembly.
- 18) Install fasteners in end cover and tighten to secure end cover to float chamber subassembly.

OVERFLOW TRAP SIZE	FLOAT BALL LEVEL
1	BOTTOM OF FLOAT BALL BETWEEN 0.0 INCHES ABOVE AND 0.168 INCHES ABOVE BOTTOM OF INNER VALVE BODY
1-1/2 & 2	BOTTOM OF FLOAT BALL BETWEEN 0.340 INCHES BELOW AND 0.112 INCHES BELOW BOTTOM OF INNER VALVE BODY
3	BOTTOM OF FLOAT BALL BETWEEN 0.050 INCHES BELOW AND 0.118 INCHES ABOVE BOTTOM OF V INNER ALVE BODY
4	BOTTOM OF FLOAT BALL BETWEEN 0.080 INCHES BELOW AND 0.102 INCHES ABOVE BOTTOM OF INNER VALVE BODY
6	BOTTOM OF FLOAT BALL BETWEEN 0.590 INCHES ABOVE AND 0.720 INCHES ABOVE BOTTOM OF INNER VALVE BODY

FLOAT BALL LEVEL ADJUSTMENT PROCEDURE

WARNING: In order to service the Type 313 Overflow Trap it is permitted to loosen or remove the hex head capscrews (Item 24), the hex head capscrews (Item 18), and the ¾ NPT square head pipe plug (Item 26). It is not permitted to loosen or remove any of the other fasteners that are part of the float chamber subassembly (Item 21). It is not permitted to loosen or remove the large square head pipe plug on the end of the float chamber subassembly opposite the end cover (Item 25). If any of the other fasteners or the large pipe plug that are part of the float chamber subassembly are loosened or removed the pressure boundary of the 313 will be compromised voiding the warranty.

- 1) Remove line pressure and isolate overflow trap. **(It is recommended that you have an Inspection Kit on hand before beginning the procedure.)**
- 2) Remove fasteners (Item 24) from end cover (Item 25).
- 3) Remove end cover from float chamber subassembly (Item 21).
- 4) Remove end cover gasket (Item 23).
- 5) Remove capscrews (Item 18) holding inner valve body (Item 15) to float chamber subassembly.
- 6) Remove internal valve assembly with float ball from float chamber subassembly.
- 7) Install internal valve assembly with float ball in float chamber subassembly with float ball extending out of the open end of the float chamber subassembly. Use clamps to secure internal valve assembly with float ball to float chamber subassembly.
- 8) Remove cotter pin (Item 7) and clevis pin (Item 6) from lever bracket (Item 8). Separate float lever (Item 5) from lever bracket.
- 9) Loosen jamnut (Item 12) on lever bracket.
- 10) Adjust engagement of lever bracket with lever bracket base (Item 13) so float ball (Item 4) level is within range of values shown in Float Ball Level Table with piston (disc) (Item 20) seated in inner valve body and pilot subassembly (Item 16) seated on piston (disc), when clevis pin, cotter pin, and float lever are reinstalled in lever bracket.
- 11) Tighten jamnut to secure lever bracket to lever bracket base. Float lever must not bind in lever bracket.
- 12) Remove clamps and remove internal valve assembly with float ball from float chamber subassembly.
- 13) Remove inner valve body gasket (Item 19).
- 14) Clean gasket surfaces of end cover, inner valve body, and float chamber subassembly.
- 15) Install new inner valve body gasket in float chamber subassembly.
- 16) Install internal valve assembly with float ball in float chamber subassembly. Watch orientation.
- 17) Install capscrews in inner valve body and tighten to secure inner valve body to float chamber subassembly.
- 18) Install new end cover gasket on float chamber subassembly. **The parts kits for Type 313 Overflow Traps size 1, 1-1/2, 2 and 3 inch contain two different end cover gaskets, see "Which end cover gasket do I use?" on page 16.**
- 19) Install end cover on float chamber subassembly.
- 20) Install fasteners in end cover and tighten to secure end cover to float chamber subassembly.

INFORMATION PRESENT ON 313 OVERFLOW TRAP

There is information present on each overflow trap ranging in importance from the part number and serial number to numbers stamped on the tank. This information is important for identifying the overflow trap, installing it correctly, and obtaining parts. **An example of the current factory serial number label used on 313 overflow traps is shown here.** The accompanying table identifies the information present and where to find it on the overflow trap. There may also be other numbers and marks present that do not provide useful information. Customer specific tagging may also present. The labels or plates used, and information present, on Warren Controls other product lines or older overflow traps may be different, contact the factory for details.

FACTORY SERIAL NUMBER LABEL



CAST TANKS NAME PLATE

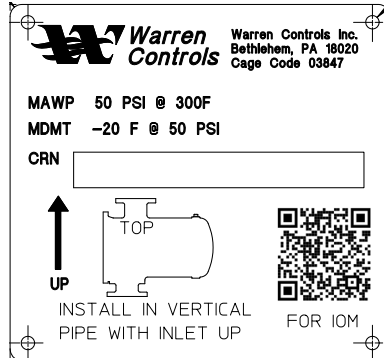

INSTALLATION ORIENTATION LABEL

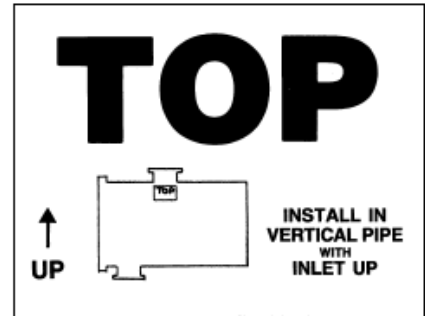

INFORMATION PRESENT ON 313 OVERFLOW TRAPS

PART NUMBER & SERIAL NUMBER			
Information	Symbol(s)	Location	Notes
Part number	P/N	On end cover	• On Factory Serial Number Label attached to end cover.
Serial Number	SERIAL NO.	On end cover and valve cover	• On Factory Serial Number Label attached to end cover. • Sales order number only stamped on valve cover.* * Number stamped using approximately 1/8 inch tall characters
INSTALLATION ORIENTATION			
Information	Symbol(s)	Location	Notes
Top of overflow trap	TOP	On tank	• On Cast Tanks Name Plate (1, 1-1/2, 2, 3 & 4 inch 313) • On Installation Orientation Label attached to side of tank. (6 inch 313)
Up direction	UP ↑	On tank	• On Cast Tanks Name Plate (1, 1-1/2, 2, 3 & 4 inch 313) • On Installation Orientation Label attached to side of tank. (6 inch 313)



QR CODE

Scan; Link will automaticall launch you to the most up-to-date version of this IOM.

313 OVERFLOW TRAP SPECIFICATIONS

313	Part Number		
Description	Size	End Connection	Part Number
CAST IRON (Size 1-4 inch) OR STEEL (Size 6 inch) BODY WITH BRONZE TRIM AND 316 ST. STL. FLOAT BALL	1	NPT	031306XXX002
	1-1/2	NPT	031308XXX002
	2	NPT	031309XXX002
	3	125 FF FLG	031311XXX002
	4	125 FF FLG	031313XXX002
	6	150 RF FLG	031315XXX001

CONDENSATE CAPACITIES

PRESSURE DROP	POUNDS / HOUR FLASHING CONDENSATE					
	Valve Size (IN)					
(PSI)	1	1-1/2	2	3	4	6
1	4,500	10,800	20,400	35,500	62,000	132,000
2	6,400	15,400	28,700	50,000	88,000	187,000
4	9,000	21,600	40,400	70,500	123,500	262,000
5	10,000	24,000	45,000	78,500	138,000	293,000
7	11,870	28,500	53,300	93,000	163,000	346,000
10	14,200	34,100	63,700	111,200	196,000	415,000
12	15,600	37,400	69,900	122,000	214,500	455,000
15	17,400	41,800	78,200	136,500	239,000	500,800

APPLICATION

Deaerators, tanks with steam blankets, produce additional liquid as the steam condenses. The 313 Overflow Trap traps and relieves this condensate through its internal pilot without the steam blanket escaping. Buoyancy of its float ball provides force to actuate internal pilot operated single seat valve assembly to relieve condensate and overflow to drain. The overflow trap should be installed in an upright position.

FEATURES

Cast Iron Chamber (size 1, 1-1/2, 2, 3 & 4 inch)
Steel Chamber (size 6 inch), brass/bronze internal valve,
316 stainless steel float ball.
Sizes 1" through 2" with NPT connections,
3" & 4" with 125 FF FLG, 6" with 150 RF FLG.
Large end cover provides easy access to internal valve assembly.

RATINGS

System operating pressures to 50 PSIG
Pressure drops to 15 PSI
Temperatures to 250F
Nominal leakage rate 0.1% of rated capacity

WEIGHTS

Weight (lb)	Valve Size (IN)					
	1	1-1/2	2	3	4	6
	120	200	200	225	259	360

All weights are for shipping purposes only.
For dimensions see drawing 03131004211.

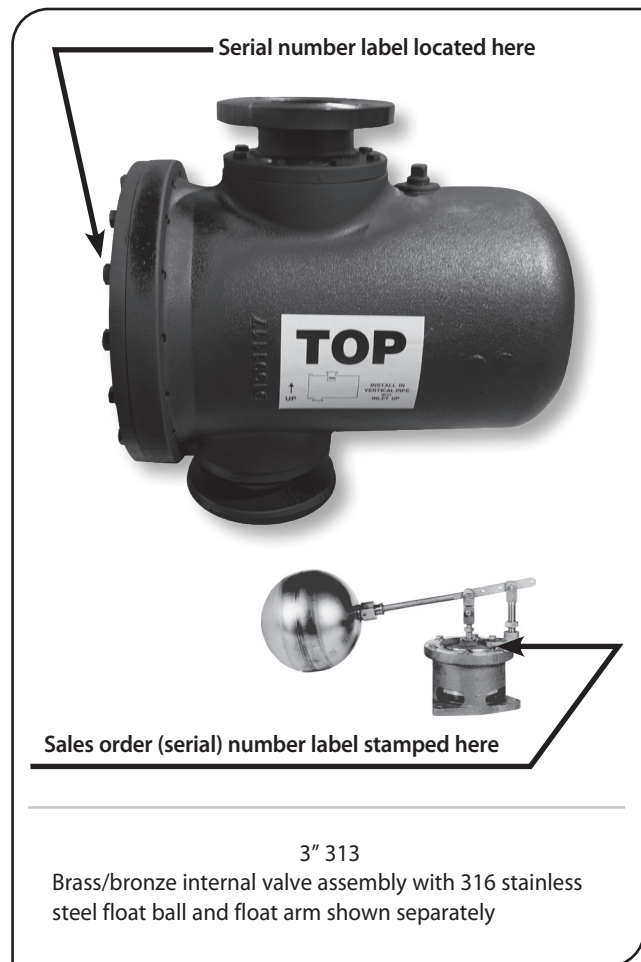

(REFER TO DRAWING 03131004211)

Damaged or worn parts can decrease performance and shorten the life of the overflow trap.

A damaged **float ball** can result in the inadequate removal of condensate and overflow.

A damaged or worn **end cover gasket** or **inner valve body gasket** can cause external leakage resulting in damage to surrounding equipment and the loss of the steam blanket from the tank.

A damaged **float lever** can result in the inadequate removal of condensate and overflow or the loss of the steam blanket from the tank.

A damaged or worn **pilot subassembly** can result in the inadequate removal of condensate and overflow or the loss of the steam blanket from the tank.

A damaged or worn **piston** can result in the inadequate removal of condensate and overflow or the loss of the steam blanket from the tank and can also cause damage to the valve body.

A damaged or worn **inner valve body** can result in the inadequate removal of condensate and overflow or the loss of the steam blanket from the tank and can also cause damage to the piston disc.

A damaged or worn **stem guide** can result in the inadequate removal of condensate and overflow or the loss of the steam blanket from the tank and can also cause damage to the pilot assembly.

A damaged or worn **clevis, clevis pin, or fulcrum link** can result in the inadequate removal of condensate and overflow or the loss of the steam blanket from the tank.

Three different parts kits are available. The inspection kit allows for the overflow trap to be opened so its internal parts may be inspected. The float ball kit allows for the float ball to be replaced. The internal vba kit allows for the entire internal valve body assembly, minus the float ball, to be replaced. The internal vba kit is preset at the factory to provide the correct water level in the float chamber. **Please provide serial number to get the correct kit or individual part numbers.**

313 OVERFLOW TRAP PARTS KITS

(PLEASE PROVIDE OVERFLOW TRAP SERIAL NUMBER TO GET CORRECT KIT PART NUMBERS)

Three different parts kits are available. The inspection kit allows for the overflow trap to be opened so its internal parts may be inspected. The float ball kit allows for the float ball to be replaced. The internal vba kit allows for the entire internal valve body assembly, minus the float ball, to be replaced. The internal vba kit is preset at the factory to provide the correct water level in the float chamber.

313 INSPECTION KIT - SEE DWG 03131004211

ITEM	QTY	DESCRIPTION	ITEM	QTY	DESCRIPTION
19	1	INNER VALVE BODY GASKET	23	2	END COVER GASKET (313 sizes 1, 1-1/2, 2 & 3 inch)
				1	END COVER GASKET (313 sizes 4 & 6 inch)

313 FLOAT BALL KIT - SEE DWG 03131004211

ITEM	QTY	DESCRIPTION	ITEM	QTY	DESCRIPTION
4	1	FLOAT BALL	23	2	END COVER GASKET (313 sizes 1, 1-1/2, 2 & 3 inch)
19	1	INNER VALVE BODY GASKET		1	END COVER GASKET (313 sizes 4 & 6 inch)

313 INTERNAL VBA KIT - SEE DWG 03131004211

ITEM	QTY	DESCRIPTION	ITEM	QTY	DESCRIPTION
1	2	CAPSCREW	13	1	LEVER BRACKET BASE
2	A / R	WASHER	14	1	INNER VALVE BODY COVER
3	A / R	CAPSCREW	15	1	INNER VALVE BODY
5	1	FLOAT LEVER	16	1	PILOT SUBASSEMBLY
6	3	CLEVIS PIN	17	1	STEM GUIDE
7	3	COTTER PIN	18	3	CAPSCREW
8	1	LEVER BRACKET	19	1	INNER VALVE BODY GASKET
9	1	FULCRUM LINK	20	1	PISTON
10	1	CLEVIS	23	2	END COVER GASKET (313 sizes 1, 1-1/2, 2 & 3 inch)
11	1	JAMNUT		1	END COVER GASKET (313 sizes 4 & 6 inch)
12	1	JAMNUT			

313 KIT PART NUMBERS

SIZE (IN)	CAST TANK (CAST), CERTIFIED DESIGN (CD), OR PRE-CERTIFIED DESIGN (PRE CD)	INSPECTION KIT	FLOAT BALL KIT	INTERNAL VALVE BODY ASSEMBLY KIT
1	CAST, CD & PRE CD	K31306XXX005	K31306XXX003	K31306XXX002
1-1/2 & 2	CAST, CD & PRE CD	K31309XXX004	K31309XXX003	K31309XXX002
3	CAST, CD & PRE CD	K31311XXX004	K31311XXX003	K31311XXX002
4	CAST, CD & PRE CD	K31313XXX004	K31313XXX003	K31313XXX002
6	CAST, CD & PRE CD	K31315XXX004	K31315XXX003	K31315XXX002

DRAWING 03131004211-1

NOTE ORIENTATION OF
FLOAT ROD TO 3 VALVE
BODY MOUNTING HOLES

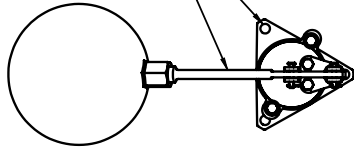

TOP VIEW 1 THRU 2 INCH
INNER VALVE BODY ASSEMBLIES

PRELIMINARY

NOTE ORIENTATION OF
FLOAT ROD TO 3 VALVE
BODY MOUNTING HOLES

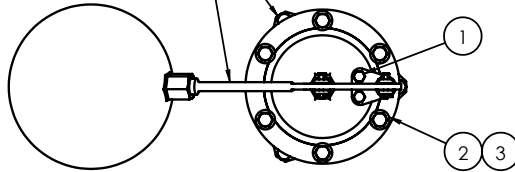

TOP VIEW 3 THRU 6 INCH
INNER VALVE BODY ASSEMBLIES

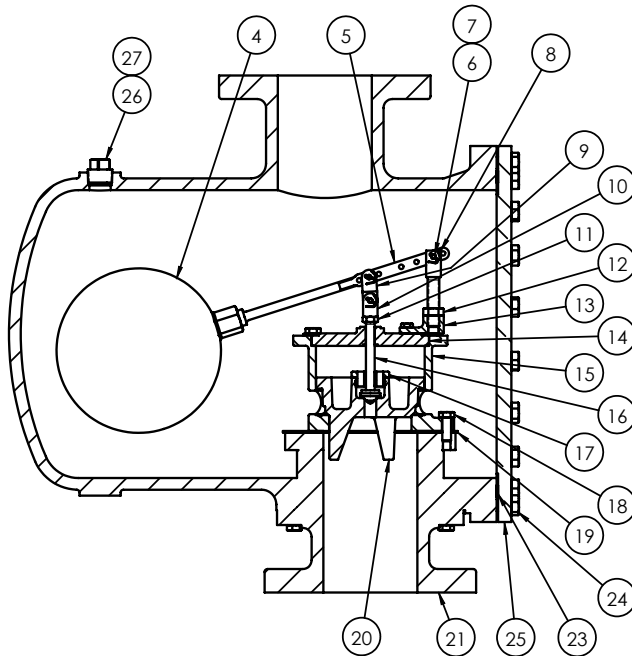
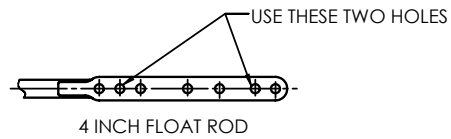
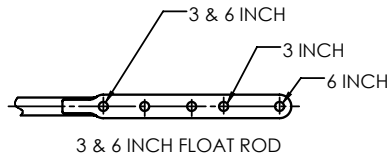
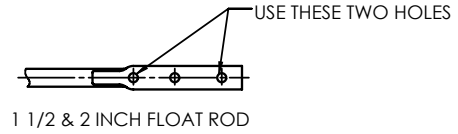
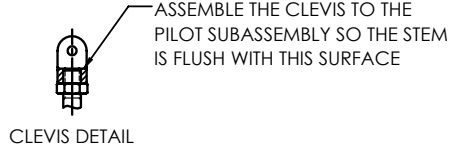

27	A/R	PST PIPE SEALANT
26	1	3/4 NPT SQUARE HEAD PIPE PLUG
25	1	END COVER
24	A/R	HEX HD CAPSCREW SEE NOTE 5
23	1	END COVER GASKET
22	1	ORIENTATION LABEL
21	1	FLOAT CHAMBER SUBASSEMBLY
20	1	PISTON
19	1	INNER VALVE BODY GASKET
18	3	HEX HD CAPSCREW
17	1	STEM GUIDE
16	1	PILOT SUBASSEMBLY
15	1	INNER VALVE BODY
14	1	INNER VALVE BODY COVER
13	1	LEVER BRACKET BASE
12	1	1/2-13 HEX JAMNUT
11	1	3/8-16 HEX JAMNUT
10	1	CLEVIS
9	1	FULCRUM LINK
8	1	LEVER BRACKET
7	3	Ø1/16 x 3/4 LG COTTER PIN
6	3	CLEVIS PIN
5	1	FLOAT LEVER
4	1	FLOAT BALL
3	A/R	HEX HEAD CAPSCREW
2	A/R	FLAT WASHER
1	2	HEX HD CAPSCREW OR ROUND HD MACHINE SCREW
ITEM	QTY	DESCRIPTION

DRAWING 03131004211-2

SIZE		A	B	C	D	E	F	G
1 INCH (25)	THD	12-7/8 (328)	9 (229)	6 (153)	5-1/2 (140)	11-1/2 (293)	3-13/16 (97)	4-3/16 (107)
1 1/2 INCH (40)	THD	18-5/16 (466)	11-1/4 (286)	7-11/16 (196)	7-11/16 (196)	13-1/2 (343)	4-11/16 (120)	6-11/16 (170)
2 INCH (50)	THD	18-5/16 (466)	11-1/4 (286)	7-1/8 (181)	7-1/8 (181)	13-1/2 (343)	4-11/16 (120)	6-11/16 (170)
3 INCH (80)	125 FLG	18-5/16 (466)	11-1/4 (286)	9-5/16 (237)	9-5/16 (237)	13-1/2 (343)	4-11/16 (120)	6-11/16 (170)
4 INCH (100)	125 FLG	20-3/4 (528)	13-1/4 (337)	11 (280)	11 (280)	16 (407)	5-3/8 (137)	7-5/16 (186)
6 INCH (150)	150 FLG	24-5/8 (626)	16 (407)	12 (305)	12 (305)	19-7/8 (505)	7-1/2 (191)	11-1/2 (293)

NOTES:

1) DIMENSIONS IN PARENTHESES ARE IN MILLIMETERS.

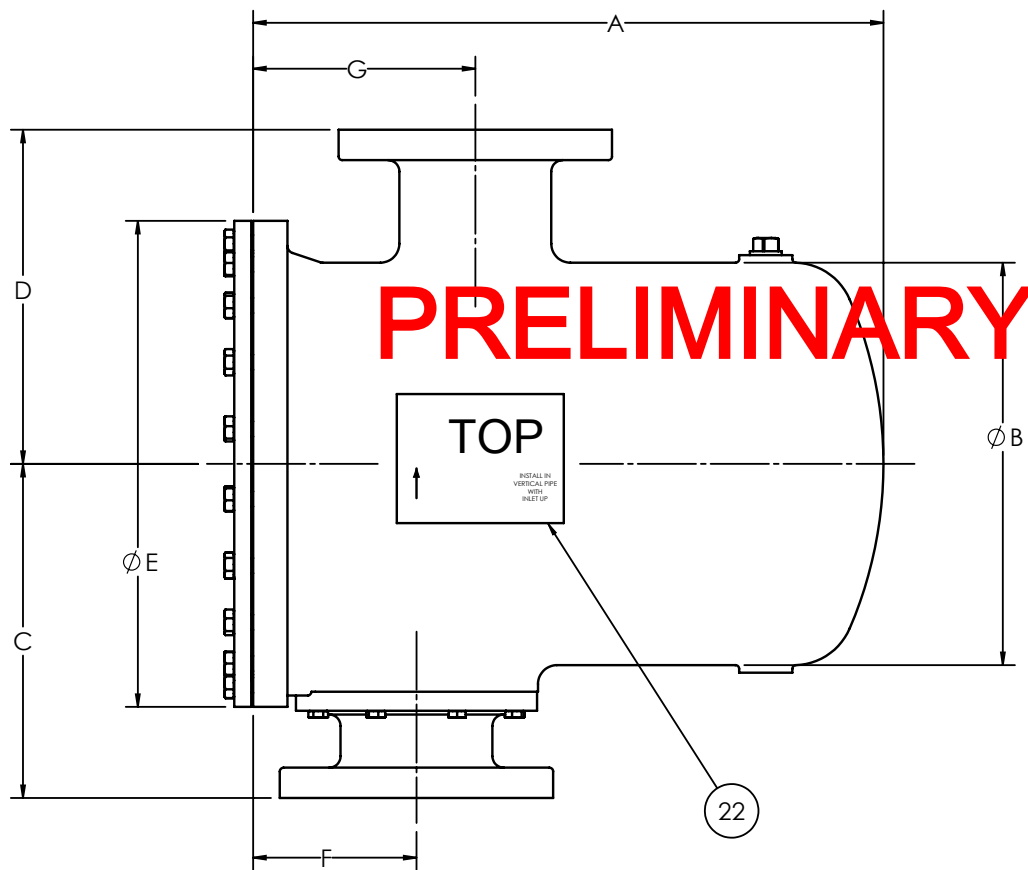

- 4) WHEN INSTALLING INNER VALVE BODY ASSEMBLY IN THE FLOAT CHAMBER, THE FLOAT BALL MUST NOT HIT THE BACK OF THE TANK AND THE FLOAT ROD MUST NOT HIT THE TANK END COVER THROUGH THE FULL RANGE OF TRAVEL.
- 3) CLEAN ALL PARTS THOROUGHLY PRIOR TO ASSEMBLY.
- 2) DO NOT INSTALL THE INNER VALVE BODY ASSEMBLY IN THE FLOAT CHAMBER UNTIL THE SET UP PROCEDURE ON SHEET 3 HAS BEEN COMPLETED.
- 1) DO NOT SECURE THE LEVER BRACKET CLEVIS PIN WITH A COTTER PIN OR TIGHTEN THE LEVER BRACKET JAMNUT UNTIL AFTER THE SETUP PROCEDURE ON SHEET 3 HAS BEEN COMPLETED.

DRAWING 03131004211-3

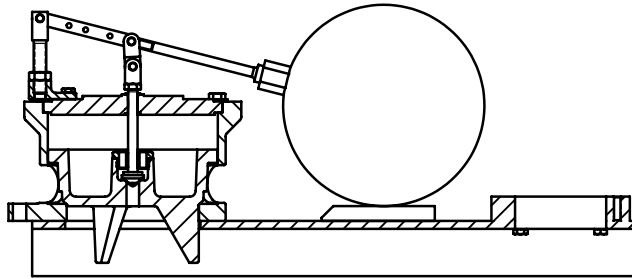

6 INCH INNER VALVE BODY ASSEMBLY ON SET UP FIXTURE

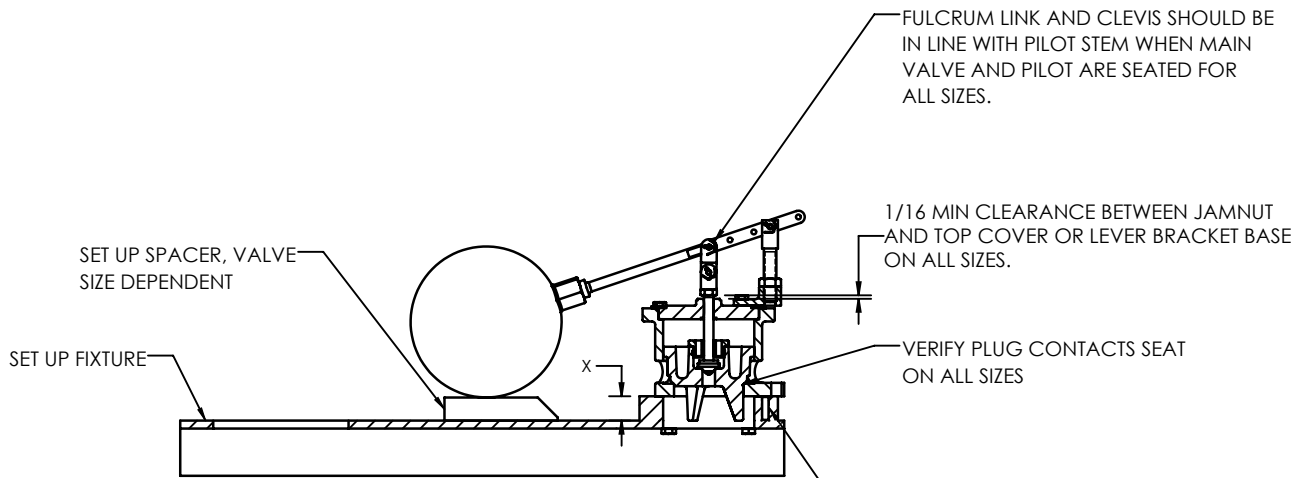

1 1/2 THRU 4 INCH INNER VALVE BODY ASSEMBLY ON SET UP FIXTURE (3 INCH SIZE SHOWN)

PRELIMINARY

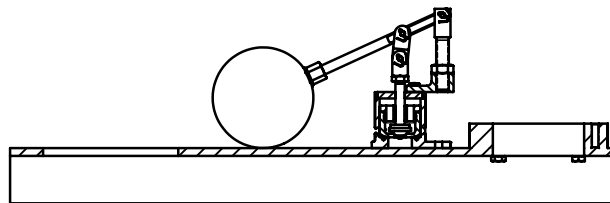

1 INCH INNER VALVE BODY ASSEMBLY ON SET UP FIXTURE

SET UP INSTRUCTIONS:

- PLACE THE INNER VALVE BODY ASSEMBLY ON THE SET UP FIXTURE AS SHOWN.
- ENSURE THAT THE PILOT STEM IS FLUSH WITH THE CLEVIS AS SHOWN ON SHEET 1 AND THAT THE JAMNUT DOES NOT HIT THE INNER VALVE BODY COVER OR LEVER BRACKET BASE WHEN THE PILOT AND PISTON ARE SEATED.
- PLACE THE APPROPRIATE SPACER UNDER THE FLOAT BALL. THE VALVE SIZE IS STAMPED ON THE END OF THE SPACERS.
- THE 1 INCH VALVE DOES NOT USE A SPACER. USE THE SURFACE THAT THE VALVE IS SITTING ON.
- ADJUST THE THE LEVER BRACKET SO THE BOTTOM OF THE FLOAT BALL IS AS CLOSE TO THE SPACER AS IT CAN BE WITHOUT TOUCHING IT WHILE THE PILOT AND PISTON ARE SEATED. AFTER IT IS ADJUSTED, THE CLEVIS AND THE FULCRUM LINK SHOULD BE ALIGNED.
- TIGHTEN THE LEVER BRACKET JAMNUT AND SECURE THE LEVER BRACKET CLEVIS PIN WITH A COTTER PIN.
- VERIFY THAT PILOT & PISTON MOVE FREELY THROUGHOUT THEIR FULL TRAVEL.

X BASE	.970
6	.590
4	.890
3	.920
2	.630
1	N/A
SIZE	SPACER THICKNESS

DRAWING 03130614111

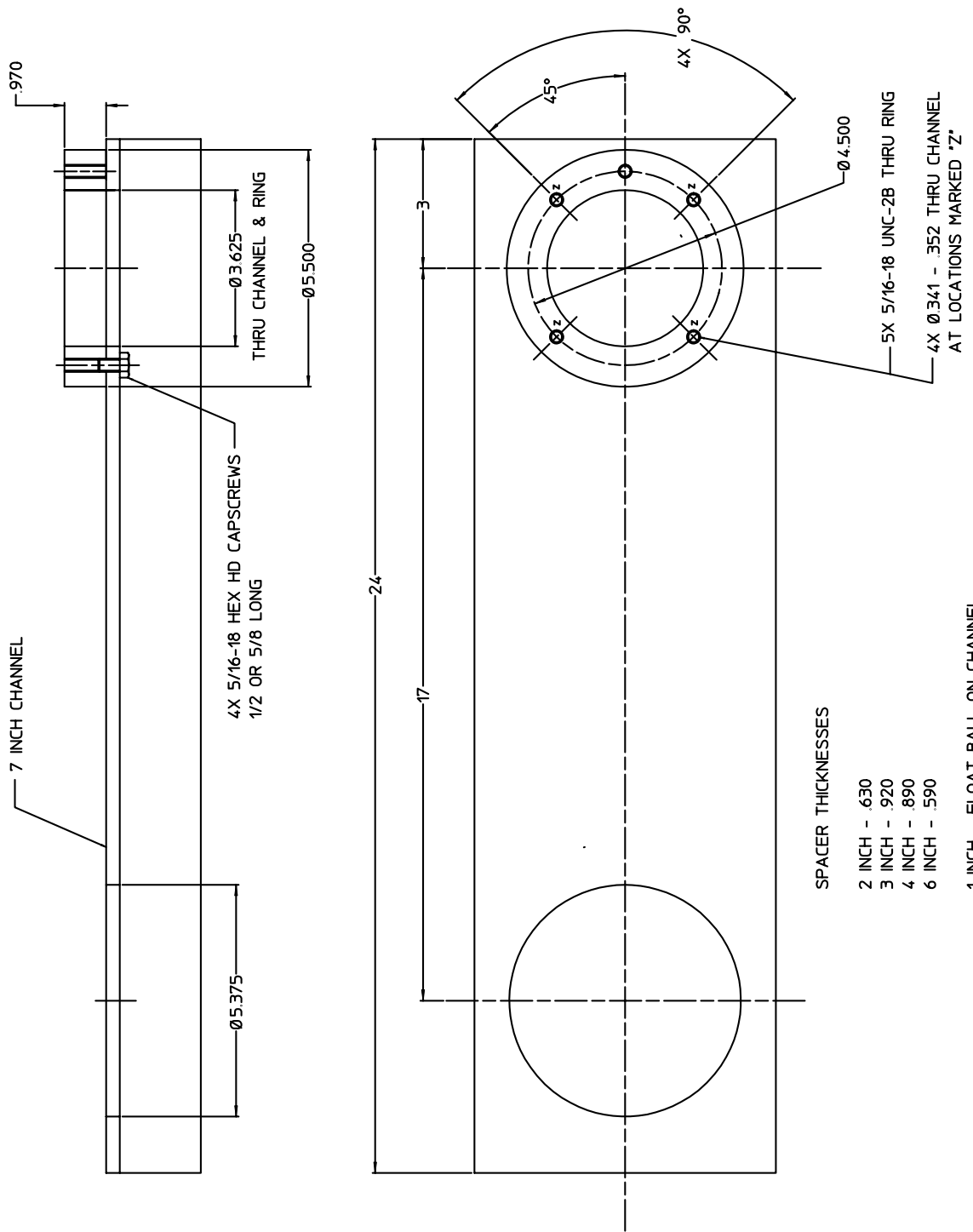

WARNING: In order to service the Type 313 Overflow Trap it is permitted to loosen or remove the hex head capscrews (Item 24), the hex head capscrews (Item 18), and the 3/4 NPT square head pipe plug (Item 26). It is not permitted to loosen or remove any of the other fasteners that are part of the float chamber subassembly (Item 21). It is not permitted to loosen or remove the large square head pipe plug on the end of the float chamber subassembly opposite the end cover (Item 25). If any of the other fasteners or the large pipe plug that are part of the float chamber subassembly are loosened or removed the pressure boundary of the 313 will be compromised voiding the warranty.

INSPECTION KIT PROCEDURE:

- 1) Remove line pressure and isolate overflow trap.
- 2) Remove fasteners (Item 24) from end cover (Item 25).
- 3) Remove end cover from float chamber subassembly (Item 21).
- 4) Remove end cover gasket (Item 23).
- 5) Remove capscrews (Item 18) holding inner valve body (Item 5) to float chamber subassembly.
- 6) Remove internal valve assembly with float ball from float chamber subassembly. Inspect float ball (Item 4). Replace with new float ball if damaged or worn. Inspect internal valve assembly. Replace with new internal valve assembly if damaged or worn.
- 7) Remove inner valve body gasket (Item 19).
- 8) Clean gasket surfaces of end cover, inner valve body, and float chamber subassembly.
- 9) Install new inner valve body gasket in float chamber subassembly.
- 10) Install internal valve assembly with float ball in float chamber subassembly. Watch orientation.
- 11) Install capscrews in inner valve body and tighten to secure inner valve body to float chamber subassembly.
- 12) Install new end cover gasket on float chamber subassembly. **The parts kits for Type 313 Overflow Traps size 1, 1-1/2, 2 and 3 inch contain two different end cover gaskets, see "Which end cover gasket do I use?" on page 16.**
- 13) Install end cover on float chamber subassembly.
- 14) Install fasteners in end cover and tighten to secure end cover to float chamber subassembly.

FLOAT BALL KIT PROCEDURE:

- 1) Remove line pressure and isolate overflow trap.
- 2) Remove fasteners (Item 24) from end cover (Item 25).
- 3) Remove end cover from float chamber subassembly (Item 21).
- 4) Remove end cover gasket (Item 23).
- 5) Remove capscrews (Item 18) holding inner valve body (Item 15) to float chamber subassembly.
- 6) Remove internal valve assembly with float ball from float chamber subassembly.
- 7) Remove inner valve body gasket (Item 19).
- 8) Clean gasket surfaces of end cover, inner valve body, and float chamber subassembly.
- 9) Remove float ball (Item 4) from float lever (Item 5). Inspect internal valve assembly. Replace with new internal valve assembly if damaged or worn.
- 10) Install new float ball on float lever.
- 11) Install new inner valve body gasket in float chamber subassembly.
- 12) Install internal valve assembly with float ball in float chamber subassembly. Watch orientation.
- 13) Install capscrews in inner valve body and tighten to secure inner valve body to float chamber subassembly.
- 14) Install new end cover gasket on float chamber subassembly. **The parts kits for Type 313 Overflow Traps size 1, 1-1/2, 2 and 3 inch contain two different end cover gaskets, see "Which end cover gasket do I use?" on page 16.**
- 15) Install end cover on float chamber subassembly. Install fasteners in end cover and tighten to secure end cover to float chamber subassembly.

INTERNAL VBA (VALVE ASSEMBLY) KIT PROCEDURE:

- 1) Remove line pressure and isolate overflow trap.
- 2) Remove fasteners (Item 24) from end cover (Item 25).
- 3) Remove end cover from float chamber subassembly (Item 21).
- 4) Remove end cover gasket (Item 23).
- 5) Remove capscrews (Item 18) holding inner valve body (Item 15) to float chamber subassembly.
- 6) Remove internal valve assembly with float ball from float chamber subassembly.
- 7) Remove inner valve body gasket (Item 19).
- 8) Clean gasket surfaces of end cover and float chamber subassembly.
- 9) Remove float ball (Item 4) from float lever (Item 5). Inspect float ball. Replace with new float ball if damaged or worn.
- 10) Install float ball on float lever of new internal valve assembly.
- 11) Install new inner valve body gasket in float chamber subassembly.
- 12) Install new internal valve assembly in float chamber subassembly. Watch orientation.
- 13) Install capscrews in inner valve body and tighten to secure inner valve body to float chamber subassembly.
- 14) Install new end cover gasket on float chamber subassembly. **The parts kits for Type 313 Overflow Traps size 1, 1-1/2, 2 and 3 inch contain two different end cover gaskets, see "Which end cover gasket do I use?" on page 16.**
- 15) Install end cover on float chamber subassembly.
- 16) Install fasteners in end cover and tighten to secure end cover to float chamber subassembly.

“WHICH END COVER GASKET DO I USE?”

Each Type 313 Overflow Trap uses one end cover gasket (Item 23).

The parts kits for the 1, 1-1/2, 2, and 3 inch Type 313 Overflow Trap contain two different end cover gaskets. The end cover gasket to be used is selected based on the construction of the Type 313 Overflow Trap.

For the 1 inch Type 313 Overflow Trap the end cover gasket to be used is selected based on the float chamber subassembly (Item 21) and the hex head capscrews, end cover fasteners, (Item 24).







If the float chamber subassembly is cast iron (cast tank, the end opposite the end cover is domed with a large square head pipe plug) and the hex head capscrews, end cover fasteners, are 0.500-13 (1/2-13), OR if the float chamber subassembly is welded steel (fabricated tank, the end opposite the end cover is flat without a large square head pipe plug) and the hex head capscrews, end cover fasteners, are 0.375-16 (3/8-16) then the end cover gasket to be used is P/N B1560962 (Nominal OD 9.63 in, ID 8.88 in, T 0.062 in).

If the float chamber subassembly is welded steel (fabricated tank, the end opposite the end cover is flat without a large square head pipe plug) and the hex head capscrews, end cover fasteners, are 0.500-13 (1/2-13) then the end cover gasket to be used is P/N B1560960 (Nominal OD 9.75 in, ID 8.75 in, T 0.062 in).

For the 1-1/2, 2, and 3 inch Type 313 Overflow Traps the end cover gasket to be used is selected based on the float chamber subassembly (Item 21).

If the float chamber subassembly is cast iron (cast tank, the end opposite the end cover is domed with a large square head pipe plug or is domed without a large square head pipe plug) then the end cover gasket to be used is P/N B1561191 (Nominal OD 11.63 in, ID 10.63 in, T 0.062 in).

If the float chamber subassembly is welded steel (fabricated tank, the end opposite the end cover is flat without a large square head pipe plug) then the end cover gasket to be used is P/N B1561190 (Nominal OD 11.875 in, ID 10.875 in, T 0.125 in).

<p>END COVER GASKET P/N B1560692 OD: 9.63 in; ID: 8.88 in; T: 0.062 in</p> <p>DOMED END WITH LARGE PIPE PLUG</p>  <p>1" 313 CAST TANK</p> <p>Cover Fasteners 0.500-13</p> <p>OR</p> <p>FLAT END WITHOUT LARGE PIPE PLUG</p>  <p>1" 313 FABRICATED TANK</p> <p>Cover Fasteners 0.375-16</p>	<p>END COVER GASKET P/N B1561191 OD: 11.63 in; ID: 10.63 in; T: 0.062 in</p> <p>DOMED END WITHOUT LARGE PIPE PLUG</p>  <p>313 CAST TANK</p> <p>Sizes: 1-1/2", 2", & 3"</p> <p>OR</p> <p>DOMED END WITH LARGE PIPE PLUG</p>  <p>313 CAST TANK</p> <p>Sizes: 1-1/2", 2", & 3"</p>
<p>END COVER GASKET P/N B1560690 OD: 9.75 in; ID 8.75 in; T: 0.062 in</p> <p>FLAT END WITHOUT LARGE PIPE PLUG</p>  <p>1" 313 FABRICATED TANK</p> <p>Cover Fasteners 0.500-13</p>	<p>END COVER GASKET P/N B1561190 OD: 11.875 in; ID 10.875 in; T 0.125 in</p> <p>FLAT END WITHOUT LARGE PIPE PLUG</p>  <p>313 FABRICATED TANK</p> <p>Sizes: 1-1/2", 2", & 3"</p>

NOTES

NOTES



313_IOM_RevDb_0622

WARREN CONTROLS

2600 EMRICK BLVD • BETHLEHEM, PA 18020 • USA • 800-922-0085 • WWW.WARRENCONTROLS.COM
DEPENDABLE, RUGGED, PRECISION CONTROL VALVES AND ACCESSORIES